



SEASTAR
SOLUTIONS®

640 North Lewis Road
Limerick, PA 19468 USA
610-495-7011
www.seastarsolutions.com

SSC61/62/72 STEERING CABLE INSTRUCTIONS

INSTALLER: THESE INSTRUCTIONS CONTAIN IMPORTANT SAFETY INFORMATION AND MUST BE FORWARDED TO BOAT OWNER.

These instructions show you how to install SSC61, SSC62, and SSC72 steering cables into the following helms:

SSC62xx and SSC61xx Cables ()

Fit these Helms (both tilt and non-tilt versions):



Figure 1

SSC72xx Cables ()
and SSC61 Cables (SSC62 w/ SA27620P CONVERTER) ()

Fit these Helms (both tilt and non-tilt versions):



Figure 2



WARNING

BEFORE STARTING INSTALLATION READ THESE INSTRUCTIONS AND ENGINE MAKERS INSTRUCTIONS THOROUGHLY. FAILURE TO FOLLOW EITHER OF THESE INSTRUCTIONS OR INCORRECT ASSEMBLY CAN RESULT IN LOSS OF CONTROL AND CAUSE PROPERTY DAMAGE OR INJURY.

DO NOT SUBSTITUTE PARTS FROM OTHER MANUFACTURERS. THEY MAY CAUSE A SAFETY HAZARD FOR WHICH SEASTAR SOLUTIONS CANNOT ACCEPT RESPONSIBILITY. USE SEASTAR SOLUTIONS STEERING CABLES ONLY WITH SEASTAR SOLUTIONS HELMS.

TO AVOID EXCESSIVE STEERING LOADS, AND TO GET THE BEST STEERING PERFORMANCE, THE OUTBOARD MOTOR OR OUTDRIVE TRIM TABS AND TILT POSITION MUST BE ADJUSTED AS INSTRUCTED IN THE MOTOR MANUFACTURERS OPERATION MANUAL. FAILURE TO DO SO CAN EFFECT THE PERFORMANCE OF THE BOAT AND ITS SAFE OPERATION.

HELMS MUST NOT BE DISASSEMBLED FOR ANY REASON. REMOVAL AND REPLACEMENT OF THE HARDWARE WHICH LOCKS THE STEERING SHAFT TO THE HELM ASSEMBLY MAY LEAD TO TOTAL FAILURE OF THE SYSTEM, WHICH COULD RESULT IN PERSONAL INJURY OR PROPERTY DAMAGE.

NOTE: Helms and cable assemblies are supplied lubricated ready for installation, do not add any lubricant to either assembly. Use of other lubricants can cause damage to the steering cable, resulting in the cable seizing or premature wear. Keep the cable and drive assembly clean during installation. Dirt will damage the system and cause premature wear. Do not take the plastic sleeve off the end of the cable until you are ready to install it into the helm.

PREPARATION FOR INSTALLATION

Before the steering cable can be installed, the helm, bezel, and steering wheel must be fully installed as shown in the bezel kit instructions.

REMOVAL OF OLD CABLE

If replacing a cable, disconnect the old cable completely from the engine, noting carefully how the connection to the engine is made. For engine-mounted cables it may be necessary to remove the engine from the boat to avoid bending the cable output end. Disconnect the cable from the helm spigot (see Figures 1 and 2 to identify your helm and follow the appropriate procedure below).

SAFE-T®QUICK CONNECT™, NFB™ SAFE-T II HELMS (AND HELMS WITH SA 27620P CONVERTER)

STEP 1. Remove hitch pin from helm (See Figure 3)

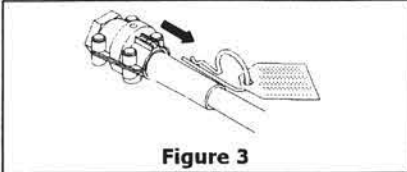

Figure 3

STEP 2. Place end of hitch pin in hole as shown and apply pressure while pulling the cable body away from the helm (See Figure 4)

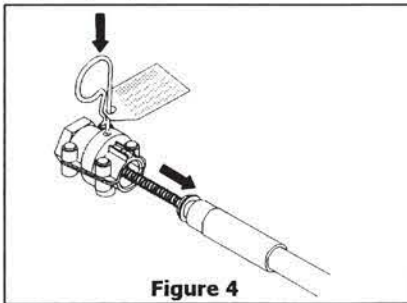

Figure 4

STEP 3. Rotate the steering wheel until the helical core of the cable is free from the helm.

BIG-T®, SAFE-T® WITH THREADED SPIGOT

STEP 1. Disconnect the cable body from helm by turning the cable-retaining nut counterclockwise until free (See Figure 5)

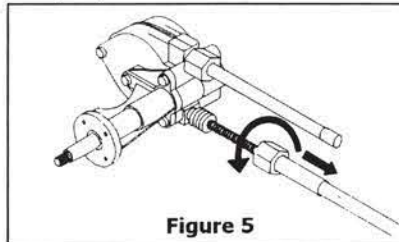

Figure 5

STEP 2. Rotate the steering wheel until the helical core of the cable is free from the helm.

NFB™ 4.2 HELMS ONLY

STEP 1. Disconnect the cable body from helm by removing the two retaining bolts in the back of the helm (See Figure 6)

NOTE: Save these two bolts for reinstallation. Do not discard.

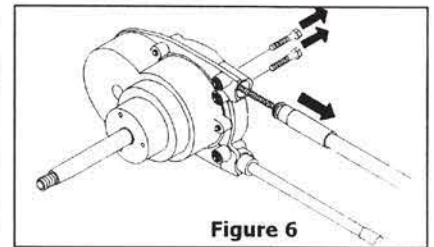

Figure 6

STEP 2. Rotate steering wheel until the helical core of the cable is free from the helm.

CABLE ROUTING

Steering cables, if possible, should be routed to the starboard side of the boat in order to balance engine torque. When routing steering cables, select a path with the minimum number of bends, making the bends as large a radius as possible. **DO NOT MAKE BENDS OF LESS THAN 8" RADIUS.** Sharp or frequent bends will result in hard steering and premature cable wear. When it is necessary to pass through a bulkhead, a 1-1/2" diameter hole is required. Cables should be clamped or tied for support at regular intervals.

CAUTION

THE CABLE MUST NOT BE BUNDLED TOGETHER WITH ELECTRICAL WIRING. THE CABLE MUST NOT REST ON SHARP EDGES WHICH CAN CAUSE CHAFING.

NEW CABLE INSTALLATION

Before the steering cable is installed the wheel should be positioned as shown in Figure 7, so that it is in the correct orientation when installation is completed. See Figures 1 and 2 to identify your helm and follow the appropriate procedure on the following page.

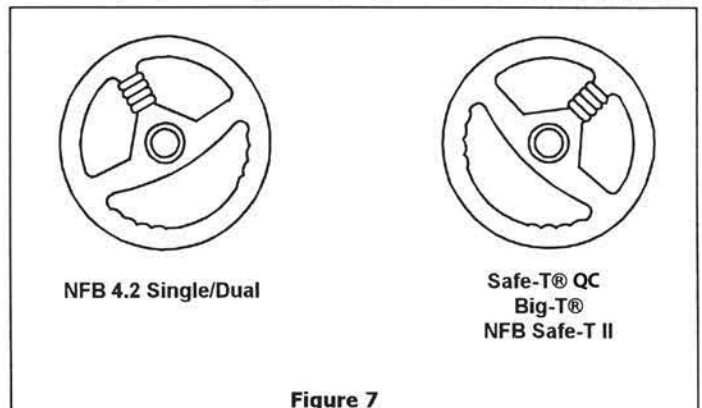

Figure 7

SAFE-T@QUICK CONNECT™ AND HELMS WITH SA 27620P CONVERTER (SINGLE HELMS ONLY)

STEP 1. If not removed already, remove hitch pin from cable entry spigot of helm (DO NOT REMOVE TAG FROM PIN).

STEP 2. Remove protective sleeve from cable end, making sure that dirt does not get onto the lubricated cable end. Feed cable end into LOWER helm entry spigot until it contacts the internal gear, then turn steering wheel counterclockwise to draw cable fully into the helm (see Figure 8). Continue turning wheel until end fitting of cable is entered into the entry spigot, and wheel cannot be turned further. During this you may hear a click as the locking mechanism engages. Turn steering wheel fully in the other direction until it cannot be turned any further, and check that cable end fitting is retained inside the entry spigot.

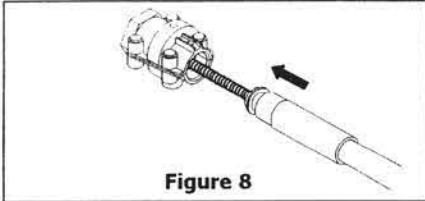

Figure 8

STEP 3. Replace pin as shown in Figure 9, making sure that it is fully seated. DO NOT REMOVE TAG FROM PIN.

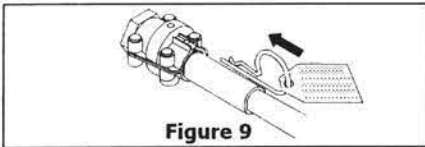

Figure 9

STEP 4. Turn steering wheel fully to both extremes of rotation and check that the cable fitting is retained in the entry spigot.

NFB™ SAFE-T II

STEP 1. If not removed already, remove pin from cable entry spigot of helm (DO NOT REMOVE TAG FROM PIN).

STEP 2. Remove protective sleeve from cable end, making sure that dirt does not get onto the lubricated cable end. Feed cable end into UPPER helm entry spigot until it contacts the internal gear, then turn steering wheel counterclockwise to draw cable fully into the helm (see Figure 10). Continue turning wheel until end fitting of cable is entered into the entry spigot, and wheel cannot be turned further. During this you may hear a click as the locking mechanism engages. Turn steering wheel fully in the other direction until it cannot be turned any further, and check that the cable end fitting is retained inside the entry spigot.

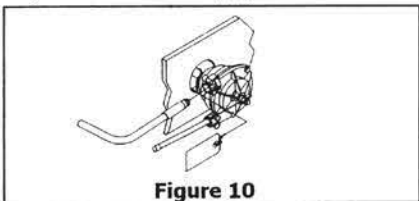

Figure 10

STEP 3. Replace pin as shown in Figures 9 and 10, making sure that it is fully seated. DO NOT REMOVE TAG FROM PIN.

STEP 4. Turn steering wheel fully to both extremes of rotation and check that the cable fitting is retained in the entry spigot.

SAFE-T@QUICK CONNECT™ AND HELMS WITH SA 27620P CONVERTER (DUAL HELMS ONLY)

STEP 1. If not removed already, remove hitch pins from cable entry spigots of helm (DO NOT REMOVE TAGS FROM PINS).

STEP 2. Push both output rams of the cables to the fully retracted position. Make sure that they stay fully retracted during installation into the helm. Remove the protective sleeves from the steering cables, and make sure that dirt does not get onto the lubricated cable ends. Hold both cables together at the helm end with the faces of the conduit fittings flush, as shown in Figure 11.

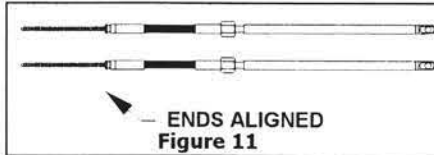

ENDS ALIGNED
Figure 11

STEP 3. Feed the cables into the LOWER helm entry spigots, keeping the conduit fittings aligned, until they contact the internal gears. Then turn the steering wheel to draw the cables fully into the helm (see Figure 12). Continue turning the wheel until the end fittings of the cables are entered into the entry spigots, and the wheel cannot be turned further. During this you may hear a click as the locking mechanism engages. Turn the steering wheel fully in the other direction until it cannot be turned any further and check that the cable end fittings are retained inside the entry spigots.

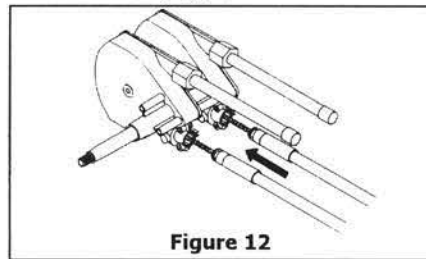

Figure 12

WARNING
IT IS POSSIBLE THAT ONE CABLE MAY NOT BE FULLY ENGAGED AT THIS TIME. CHECK THAT BOTH CABLES ARE FULLY ENGAGED BY PUSHING EACH CABLE FULLY HOME TO SEAT THEM PROPERLY.

STEP 4. Replace the pins as shown in Figure 9, making sure that they are fully seated. If one pin cannot be inserted, that cable is not fully seated in the helm. Push on the cable to ensure that it is fully home. DO NOT REMOVE TAGS FROM HITCH PINS.

STEP 5. Rotate the steering wheel several times from stop to stop, and watch the movement of the steering cable's output rams. Turning the wheel clockwise should cause the ram to extend.

BIG-T®, SAFE-T® w/ THREADED SPIGOT (SINGLE HELMS ONLY)

STEP 1. Remove the protective sleeve from the steering cable, making sure that dirt does not get onto the lubricated cable end. Feed the cable end into the LOWER helm entry spigot until it contacts the internal gear. Then turn the steering wheel to draw the cable fully into the helm (see Figure 13). Continue turning the steering wheel until the end fitting of the cable is flush with the entry spigot.

STEP 2. Thread the steering cable coupler nut onto the lower entry spigot and tighten securely. NOTE: The coupler nut has a locking ring in the threads. Make sure the nut is drawn up fully and the locking ring is engaged. Threads will not be visible when correctly installed. If you do not tighten this nut fully there will be excessive play in the steering wheel.

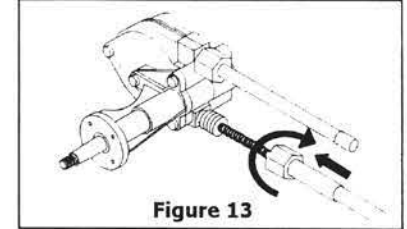
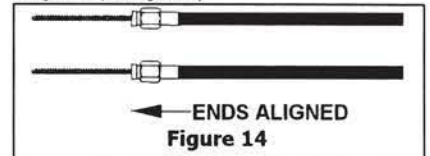

Figure 13

STEP 3. Rotate the steering wheel several times from stop to stop, and watch the movement of the steering cable output ram. Turning the wheel clockwise should cause the ram to extend.

SAFE-T® w/ THREADED SPIGOT (DUAL HELMS ONLY)

STEP 1. Push both output rams of the cable to the fully retracted position. Make sure that they stay fully retracted during installation into the helm. Remove the protective sleeves from the Steering Cables, making sure that dirt does not get onto the lubricated cable ends. Hold both cables together at the helm end with the faces of the conduit fittings flush (see Figure 14).



ENDS ALIGNED
Figure 14

STEP 2. Feed the cable ends into the LOWER entry spigots, keeping the conduit fittings aligned, until they contact the internal gears. Then turn the steering wheel to draw the cables fully into the helm. Continue turning the steering wheel until the conduit end fittings are flush with the entry spigots (see Figure 15).

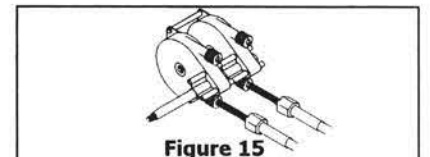

Figure 15

STEP 3. Thread the steering cable coupler nuts onto the LOWER entry spigots and tighten securely. NOTE: The coupler nuts have locking rings in the threads. Make sure the nuts are drawn up fully and the locking rings are engaged. Threads will not be visible when correctly installed. If you do not tighten these nuts fully, there will be excessive play in the steering wheel.

STEP 4. Rotate the steering wheel several times from stop to stop, and watch the movement of the steering cable output rams. For starboard mounted helms turning the steering wheel clockwise should cause the ram to extend.

NFB™ 4.2 (SINGLE HELMS ONLY)

STEP 1. Remove the protective sleeve from the steering cable, making sure that dirt does not get onto the lubricated cable end.

STEP 2. Feed the cable end into the UPPER helm entry spigot until it contacts the internal gear; then turn the steering wheel to draw the cable fully into the helm (see Figure 16). Continue turning the steering wheel until the end fitting of the cable is fully inserted into the entry spigot.

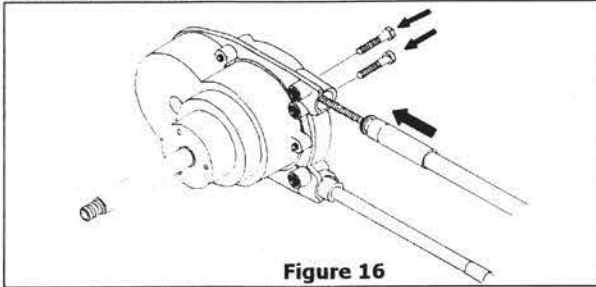

Figure 16

STEP 3. Insert the two bolts saved during cable removal (see page 2, step 1 of "Removal of Old Cable - NFB 4.2 Helms Only") into the helm and tighten fully, making sure that the bolt is in the retaining groove of the cable fitting.

STEP 4. Rotate the steering wheel several times from stop to stop, and watch the movement of the steering cable output ram. On starboard mounted helms turning the wheel clockwise should cause the ram to extend.

NFB™ (DUAL HELMS ONLY)

STEP 1. Push both output rams of the cables to the fully retracted position. Make sure that they stay fully retracted during installation into the helm. Remove the protective sleeves from the steering cables, and make sure that dirt does not get onto the lubricated cable ends. Hold both cables together at the helm end with the faces of the conduit fittings flush, as shown in Figure 11.

STEP 2. Feed the cable ends into the UPPER entry spigots, keeping the conduit fittings aligned, until they contact the internal gears. Then turn the steering wheel to draw the cables fully into the helm. Continue turning the wheel until both conduit end fittings are fully inserted into the entry spigots (see Figure 17).

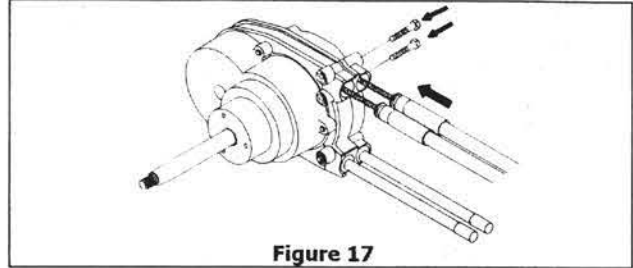

Figure 17

STEP 3. Insert the two bolts saved during cable removal (see page 2, step 1 of "Removal of Old Cable - NFB 4.2 Helms Only") into the helm and tighten fully, making sure that the bolt is in the retaining groove of the cable fitting.

STEP 4. Rotate the steering wheel several times from stop to stop, and watch the movement of the steering cable output ram. On starboard mounted helms turning the wheel clockwise should cause the ram to extend.

CONNECTION TO ENGINE (SINGLE CABLE SYSTEMS)

For engine-mounted steering systems, slide the output ram through the engine support tube. Thread the cable coupler nut fully onto the support tube. **NOTE:** The coupler nut has a locking ring in the threads. Make sure the nut is drawn up fully and its internal plastic locking ring is engaged. If you do not tighten this nut fully there will be excessive play in the steering system. Connect the cable output ram to the engine tiller arm as shown in the instructions packed with the connection kit. Grease output ram before installation.

CAUTION

ENSURE THAT THE CABLE OUTPUT END IS NOT BENT WHEN INSTALLING. IF NECESSARY, THE ENGINE MUST BE REMOVED FROM THE BOAT.

For a boat-mounted steering system, attach the cable to the boat and engine in accordance with the instructions furnished with the connection kit.

CONNECTION TO ENGINE (DUAL CABLE SYSTEM)

The steering cables can now be connected to the engine, using a connection kit available from the engine maker or an approved equivalent. The adjustment of dual cable connection kits is critical for smooth easy steering. The instructions provided by the kit maker **MUST** be followed. Grease output rams before installation.

CAUTION

ENSURE THAT THE CABLE OUTPUT END IS NOT BENT WHEN INSTALLING. IF NECESSARY, THE ENGINE MUST BE REMOVED FROM THE BOAT.

To fine tune the steering, install the connection kit without adjusting the second cable tube. Turn the steering wheel so that you get a feel of the load to move the engine. Move the engine from side to side and check the amount of free play in the cables. Adjust the connection kit tube until as much of the free play is removed as possible **WITHOUT INCREASING THE LOAD AT THE STEERING WHEEL.** There may be a small amount of free play at the steering wheel. This is normal and cannot be removed by adjusting the connection kit. Tighten both adjusting nuts and test drive the boat. Readjust the connection kit if necessary.

OPERATION & MAINTENANCE NOTES

CAUTION

IT IS POSSIBLE TO OVERTRIM THE ENGINE AND INCREASE THE STEERING TORQUE TO THE POINT THAT THE STEERING WHEEL CANNOT BE TURNED, EVEN THOUGH THE TORQUE IS NOT FELT AT THE WHEEL. THIS MAY GIVE THE IMPRESSION THAT THE STEERING IS "LOCKED". THIS CONDITION CAN OCCUR MORE WHEN JACK PLATES ARE USED TO RAISE THE ENGINE ON THE TRANSOM, AND CAN ONLY BE OVERCOME BY REDUCING THE BOAT SPEED OR ENGINE TRIM OUT POSITION. UNTIL YOU ARE COMPLETELY FAMILIAR WITH THE BOAT AND THE EFFECTS OF POWER TRIM, MAKE ALL ADJUSTMENTS OF TRIM WITH EXTREME CAUTION.

1. After a few hours of operation and at frequent intervals thereafter, check all fasteners and the complete steering system for security and integrity.

DANGER

LOOSENING OR LOSS OF ONE OR MORE FASTENERS MAY CAUSE FAILURE OF THE STEERING SYSTEM, RESULTING IN LOSS OF STEERING CONTROL AND COULD CAUSE PERSONAL INJURY OR PROPERTY DAMAGE.

2. Keep all moving parts free from build-up of salt and other foreign material. This will affect their operation and create steering problems. Pay particular attention to the hinge tube of outboard motors. Periodically remove the cable, clean hinge tube thoroughly and lubricate both the hinge tube and telescopic end of the cable with a waterproof grease.

3. Periodically inspect all visible parts for corrosion. Any parts affected by corrosion must be replaced. When replacing hardware, self-locking hardware must be used.

4. Inspect steering cable periodically for cracks or other damage. If any is found the cable must be replaced.

NOTE: If steering gets harder (stiffer) to operate the cable must be replaced.

DANGER

DO NOT COVER CRACKS WITH TAPE OR OTHER SEALANTS, THIS WILL CREATE A HAZARD IN WHICH THE CABLE CAN FAIL SUDDENLY WITHOUT WARNING.

KEEP THESE INSTRUCTIONS WITH YOUR BOAT FOR FUTURE REFERENCE.